

MAYOR STREET BLOCK L

CONSTRUCTION DRAWINGS – MIXED USE DEVELOPMENT (OFFICE DEVELOPMENT DRAWINGS)

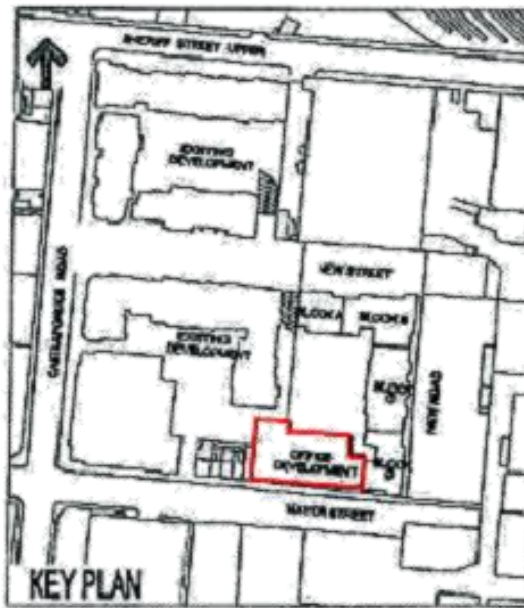

SITE MAP

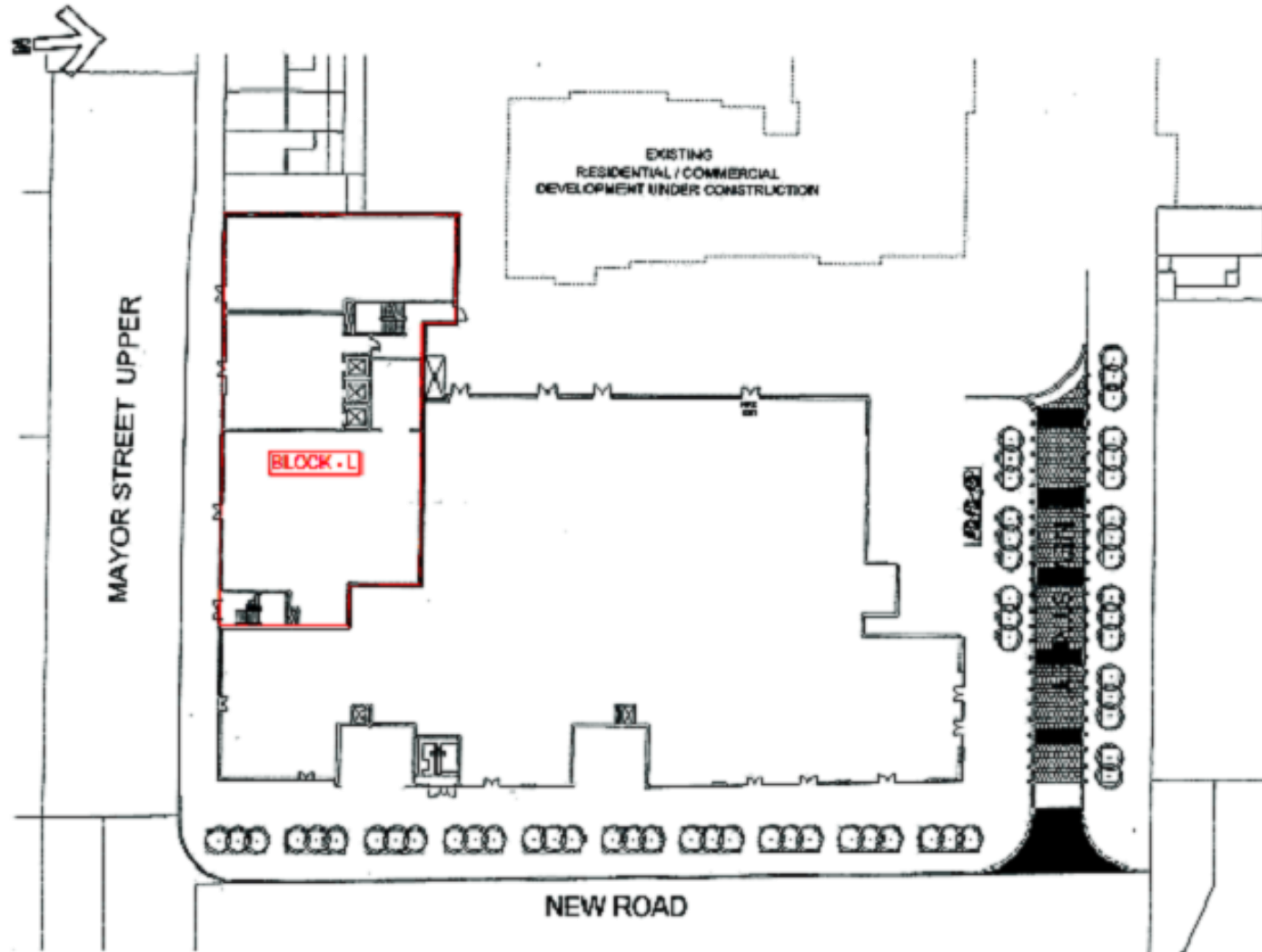

BLOCK L

TYPICAL BLOCK-L LAYOUT PLAN

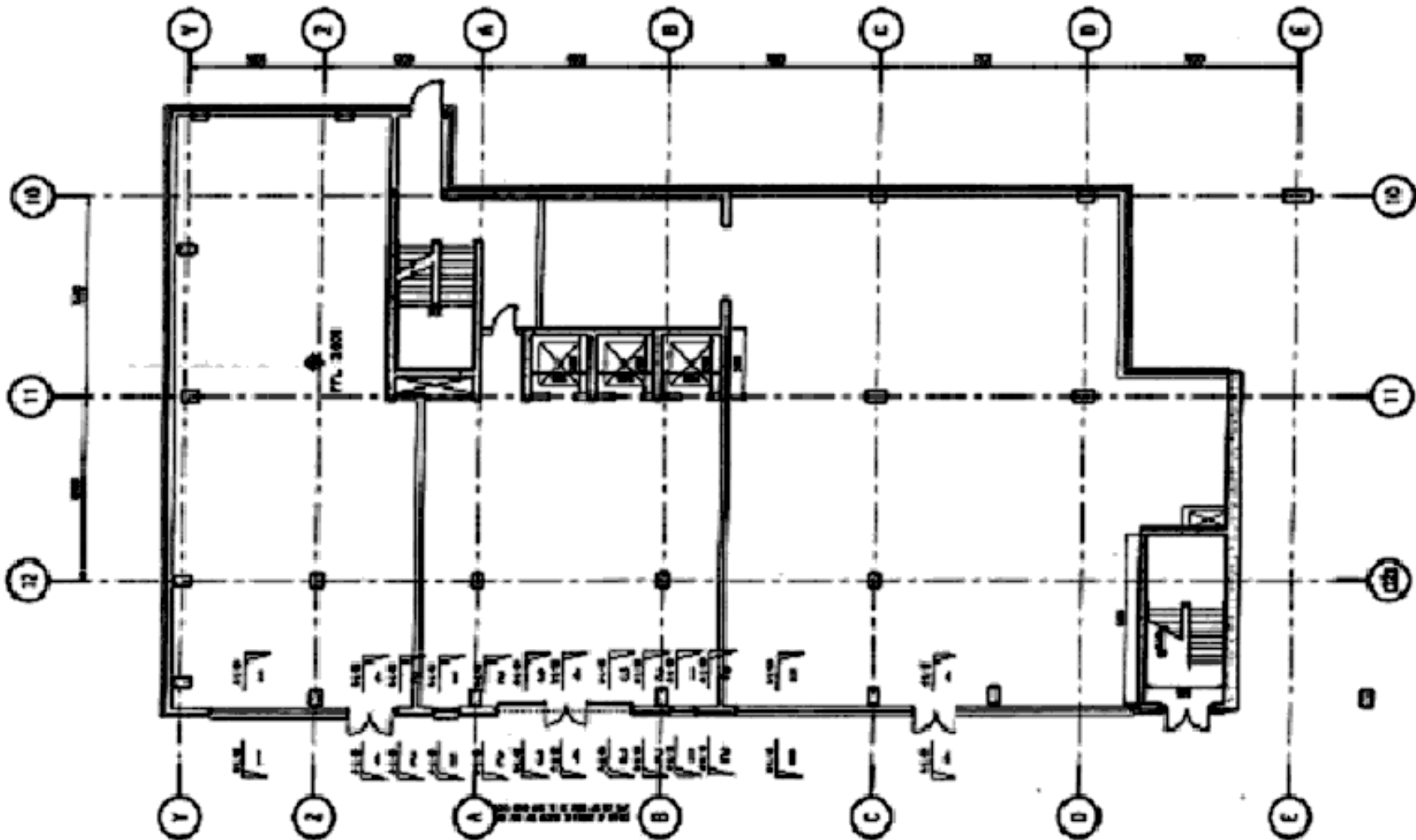

BLOCK L

FRONT ELEVATION

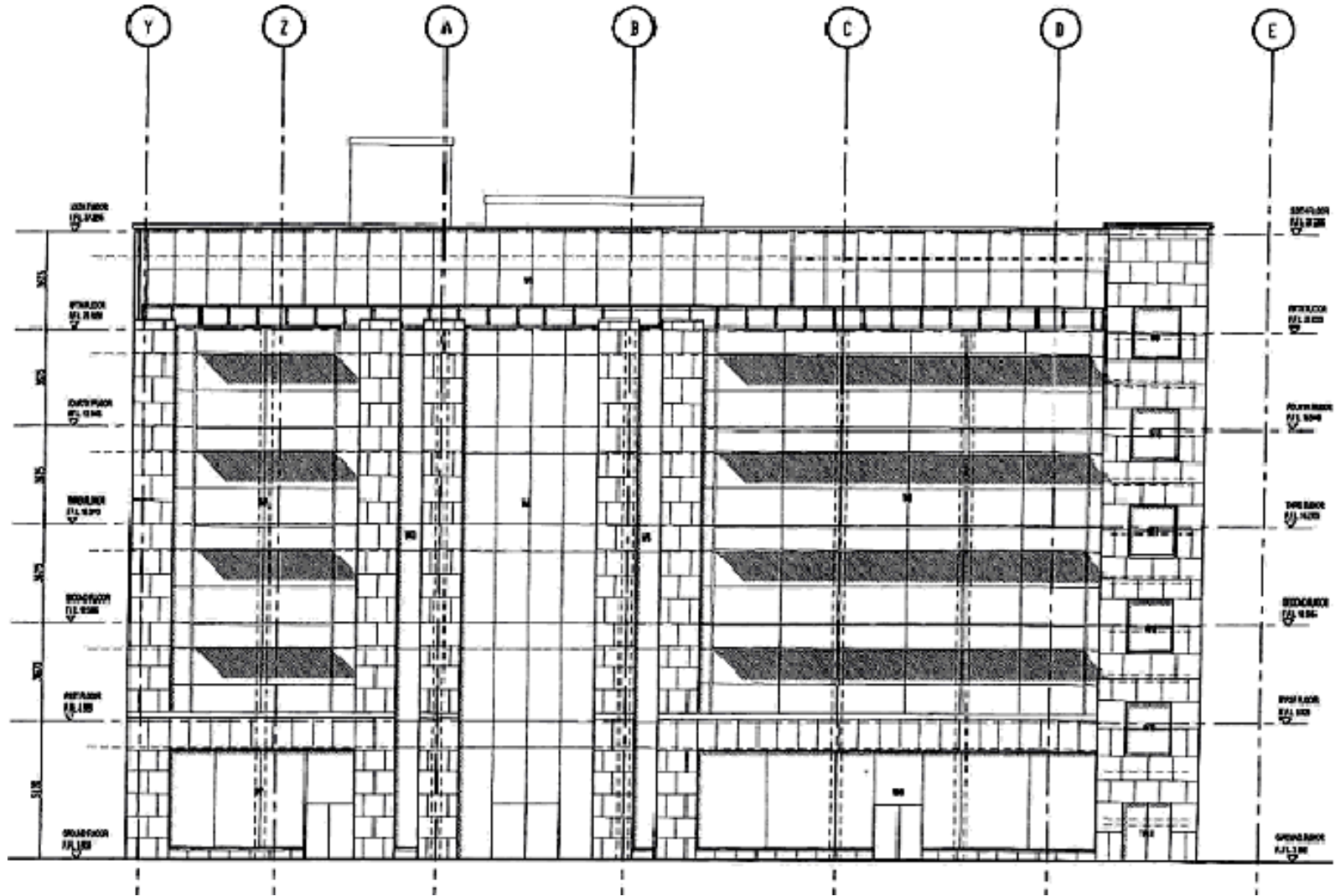

SOUTH ELEVATION

REAR ELEVATION

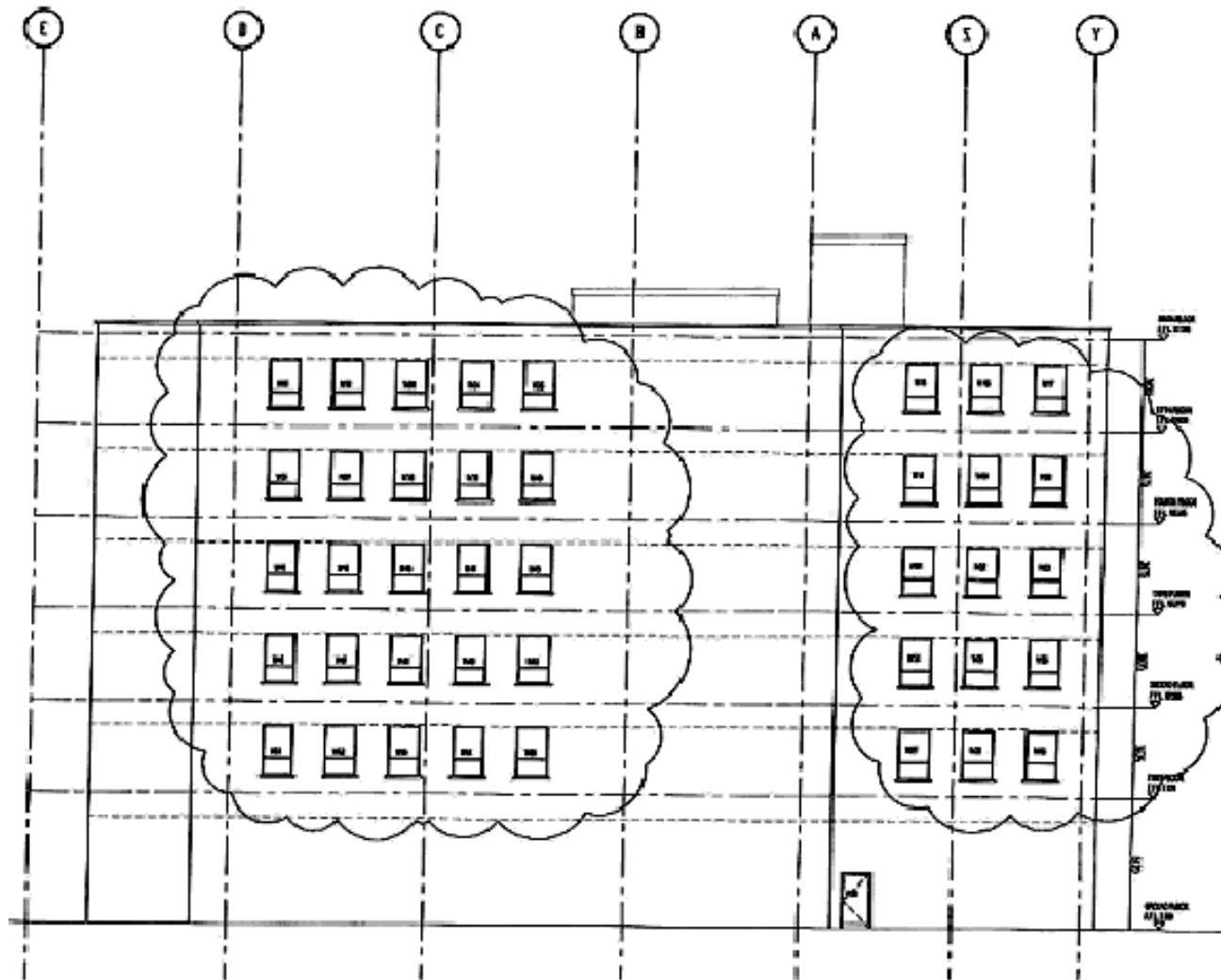

NORTH ELEVATION

GROUND FLOOR DETAILS 1

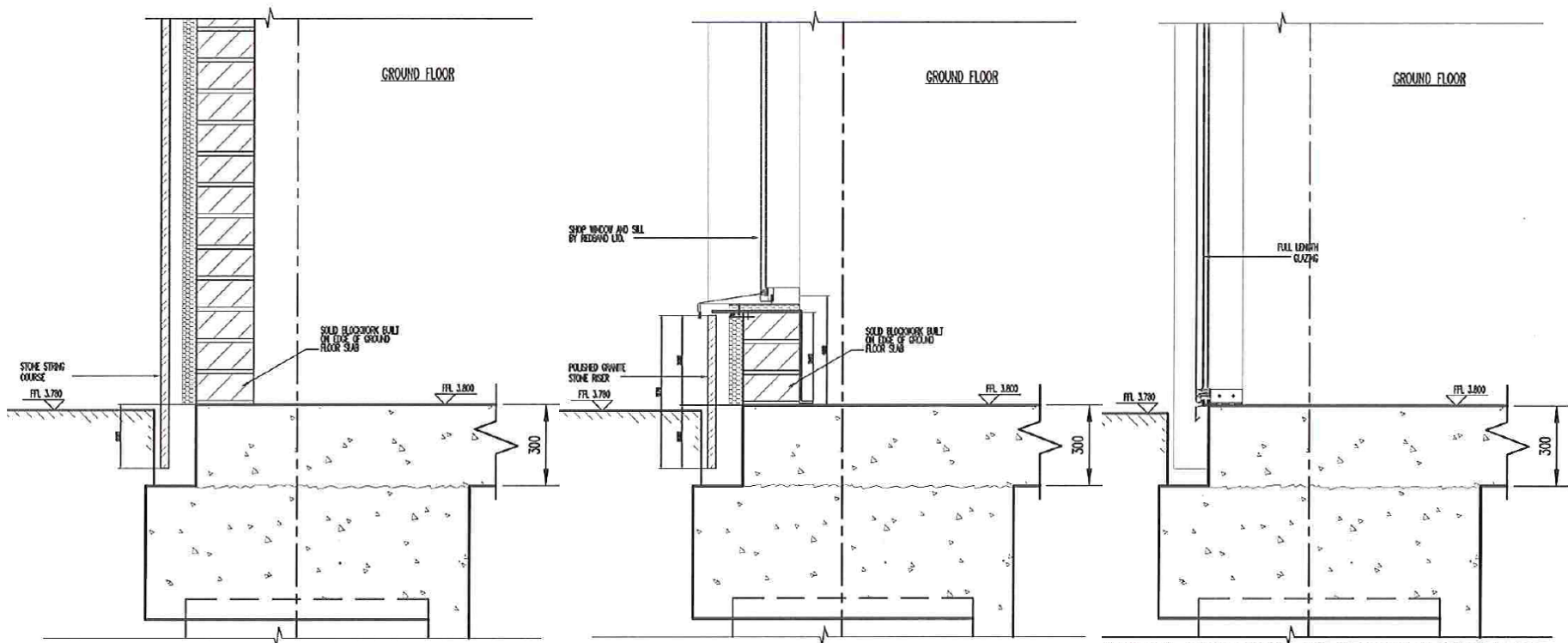

SECTION 1-1
TYPICAL SECTION THROUGH
SHOP FRONT

SECTION 2-2
TYPICAL SECTION THROUGH
BLOCK WALL

SECTION 3-3
TYPICAL SECTION THROUGH
GLAZING

GROUND FLOOR DETAILS 2

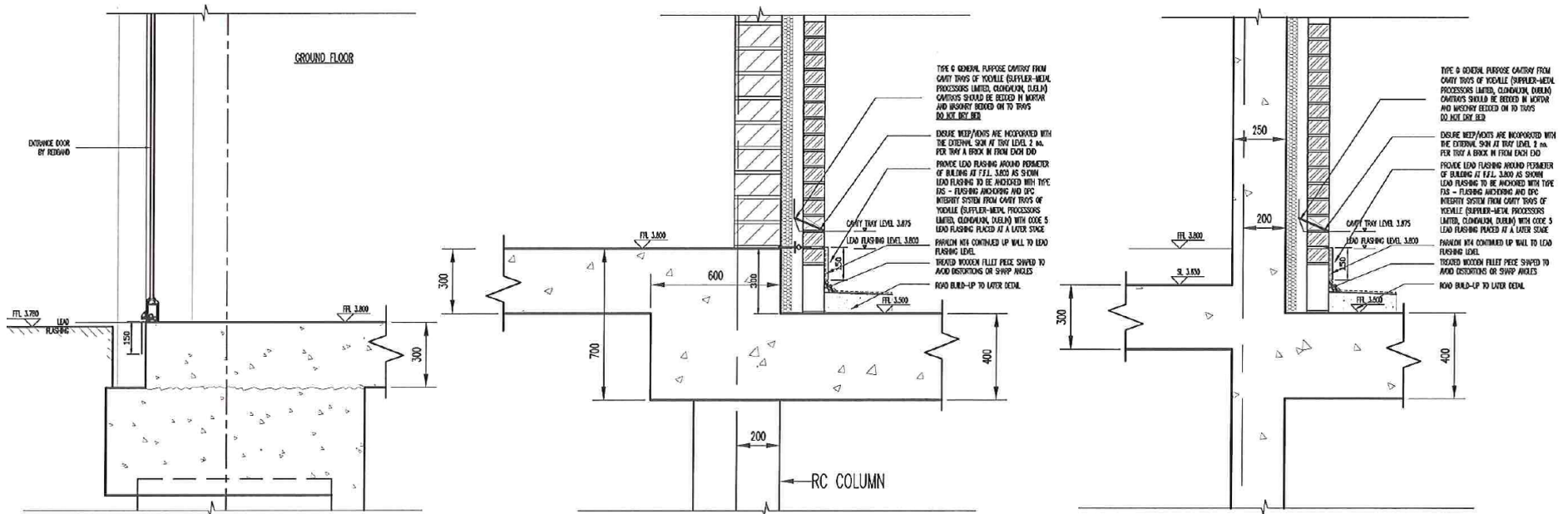

FIRST FLOOR DETAILS 1

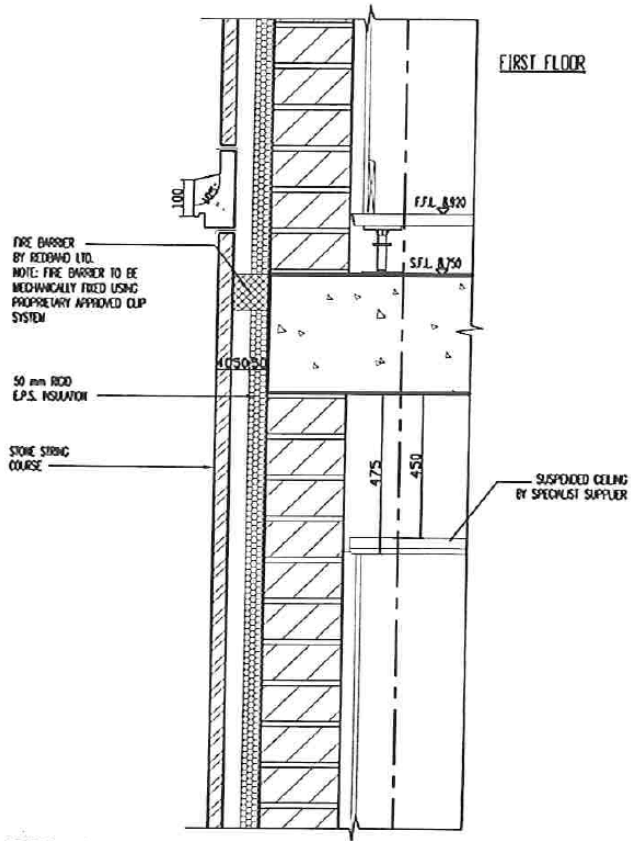

**SECTION 7-7
TYPICAL SECTION THROUGH
HEAD**

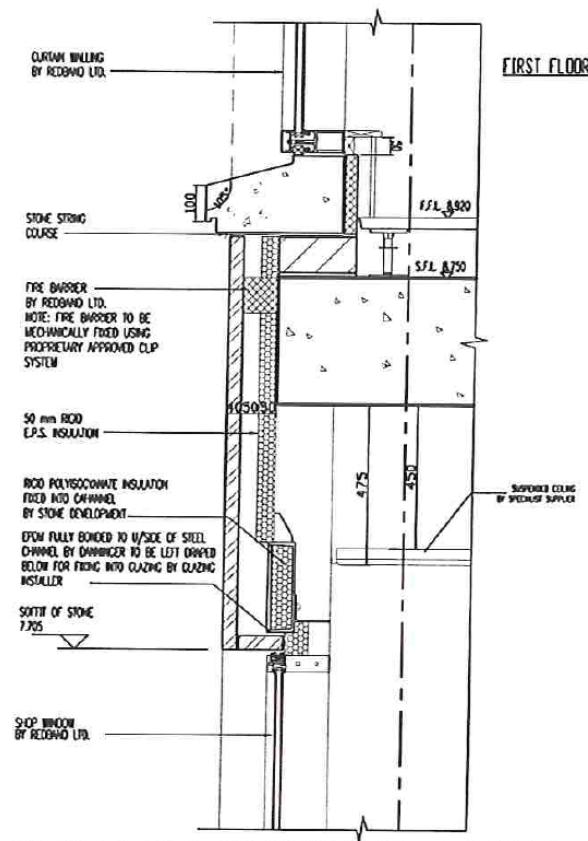

**SECTION 8-8
TYPICAL SECTION THROUGH
HEAD**

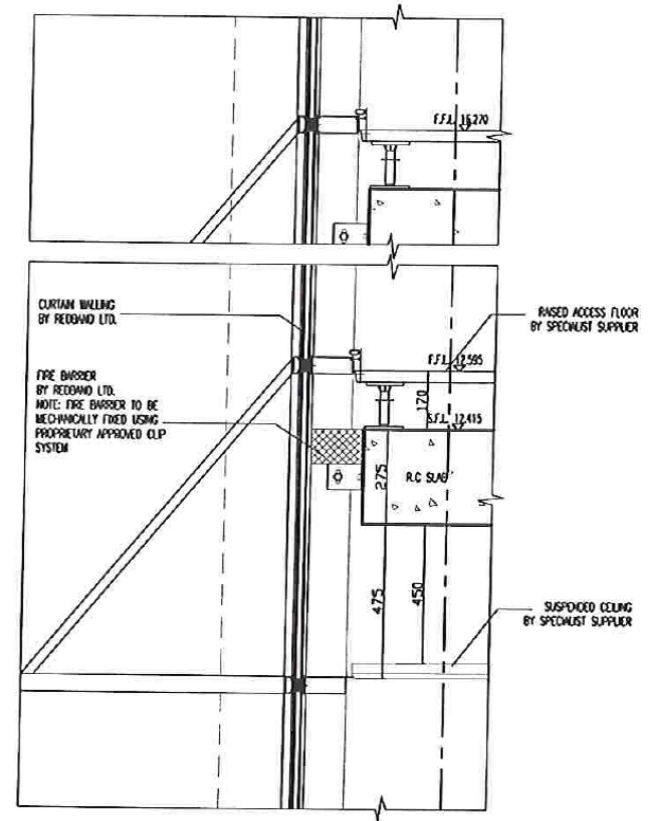

**SECTION 9-9
TYPICAL SECTION THROUGH
CURTAIN WALLING**

FIRST FLOOR DETAILS 2

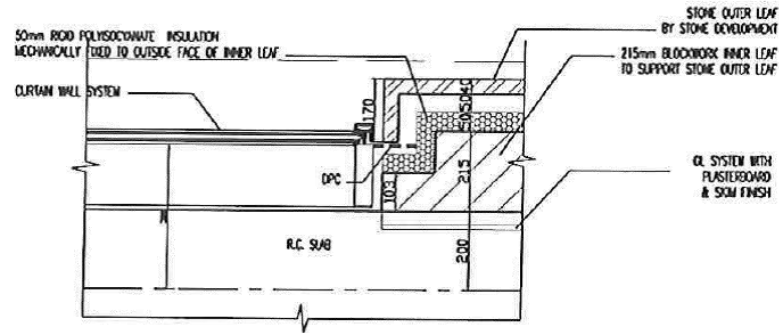

SECTION 10-10 TYPICAL SECTION THROUGH STONE, BLOCK AND CURTAIN WALLING

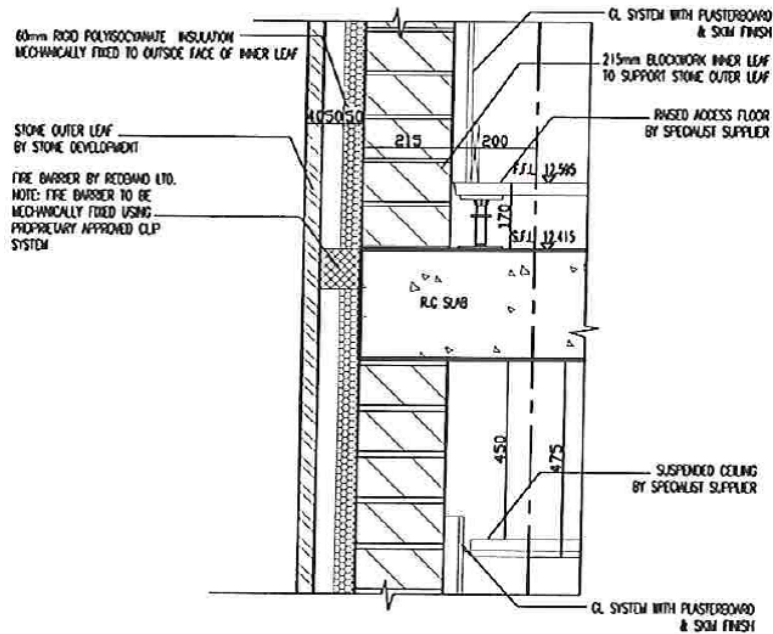

SECTION 11-11 TYPICAL SECTION THROUGH STONE

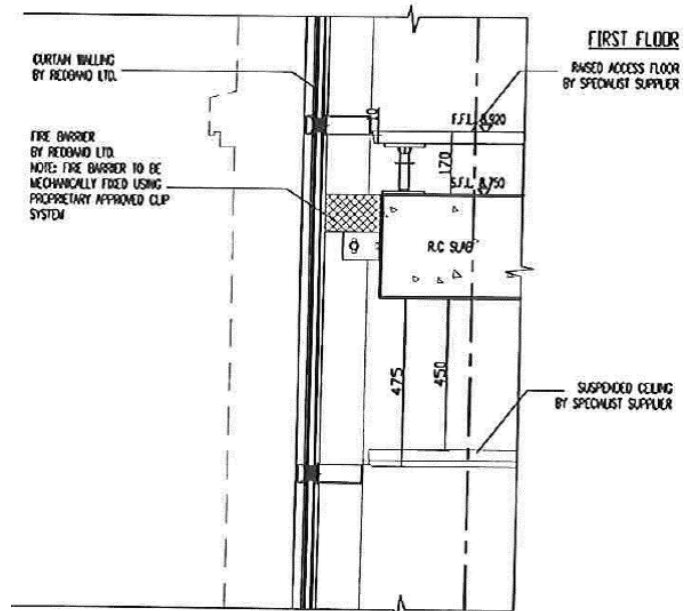

SECTION 12-12 TYPICAL SECTION THROUGH CURTAIN WALLING

ROOF DETAILS 1

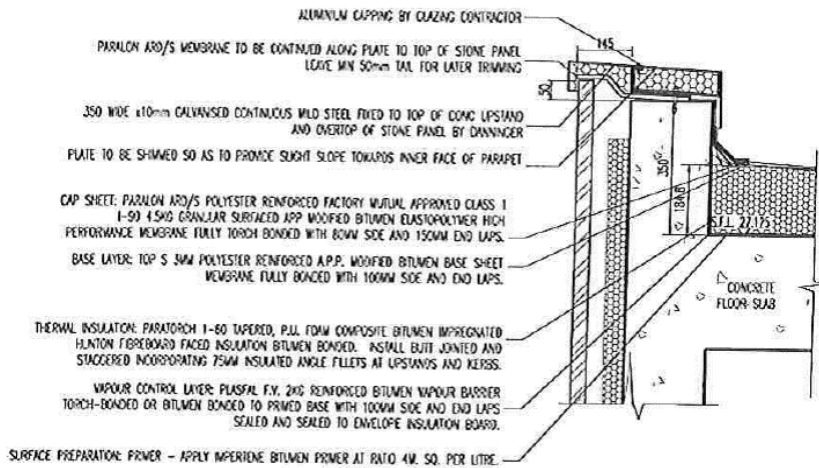

**SECTION 19-19 TYPICAL PARAPET DETAIL
CONCRETE STAIR CORE AND STONE**

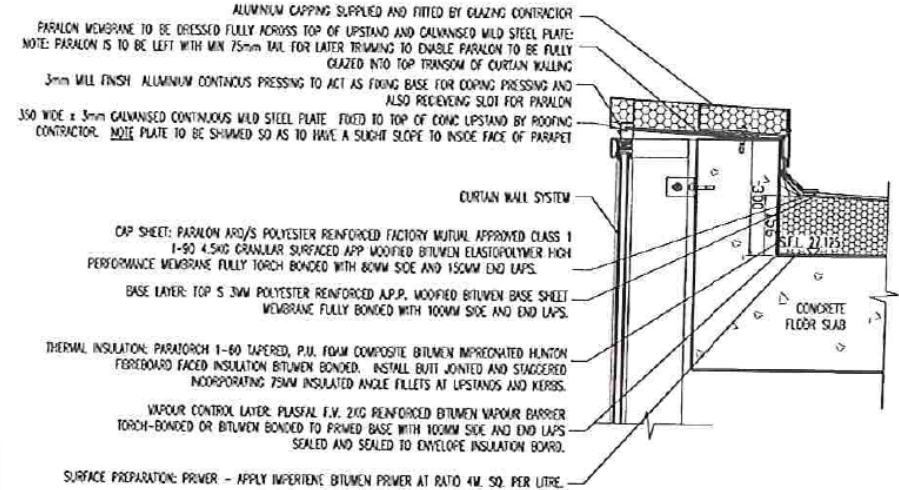

**SECTION 12-12 TYPICAL PARAPET DETAIL
CURTAIN WALL GLAZING**

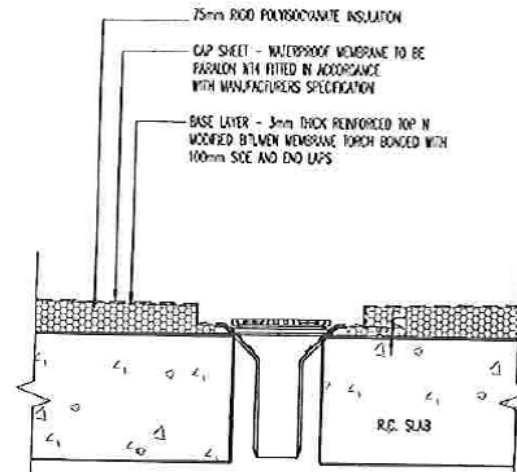

**SECTION 21-21 TYPICAL ROOF INSULATION BUILD-UP
AND RAIN WATER DRAINAGE**

ROOF DETAILS 2

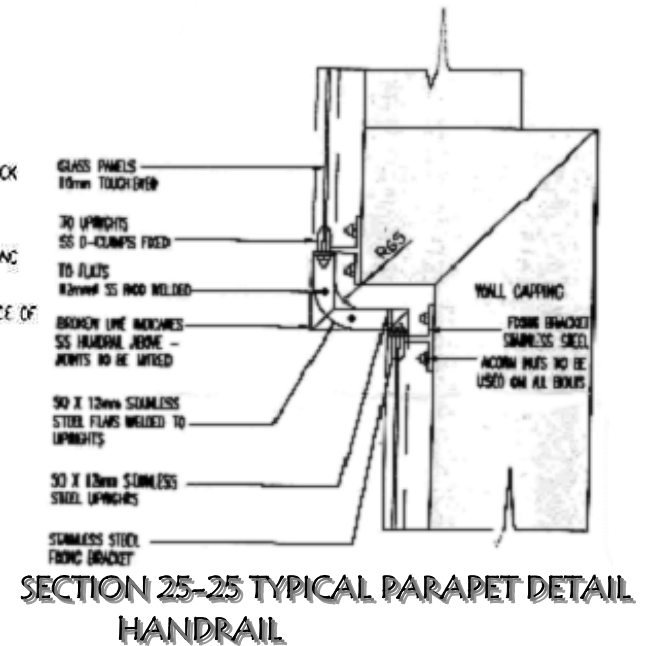
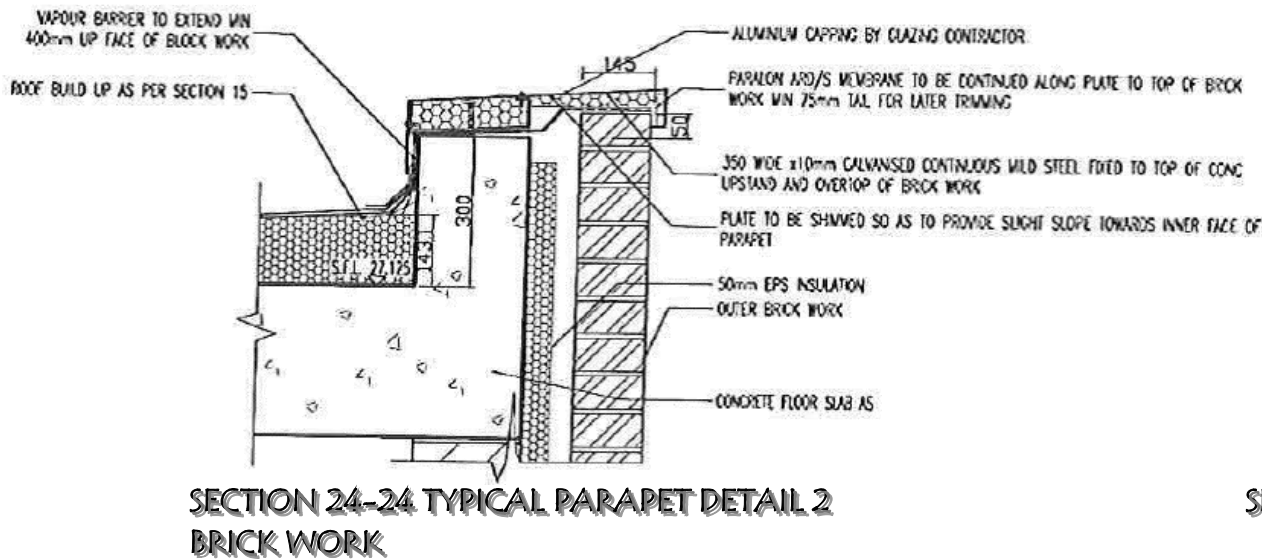
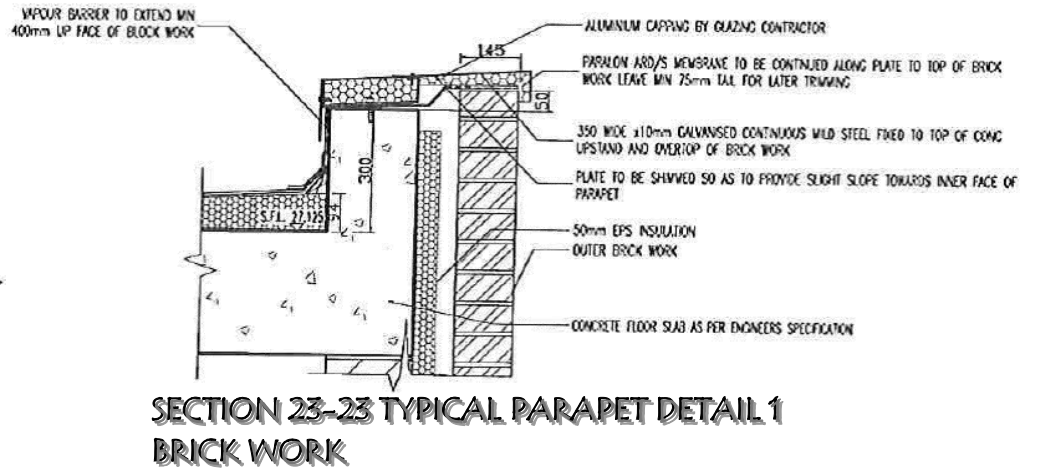
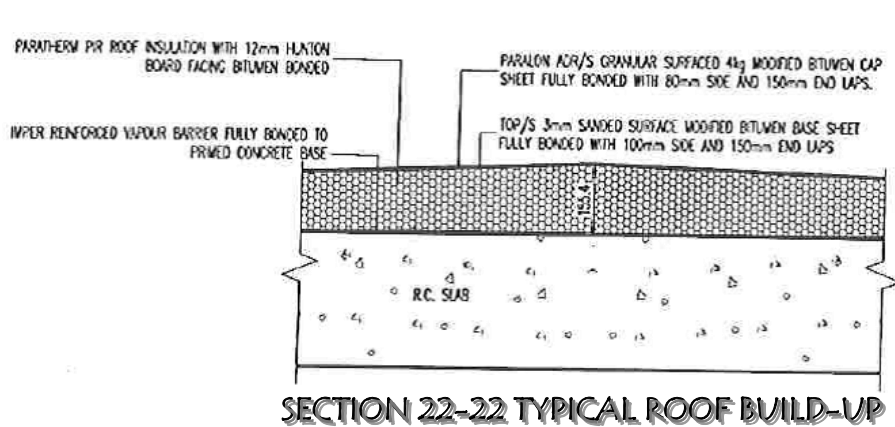

ROOF BALCONY DETAIL 1

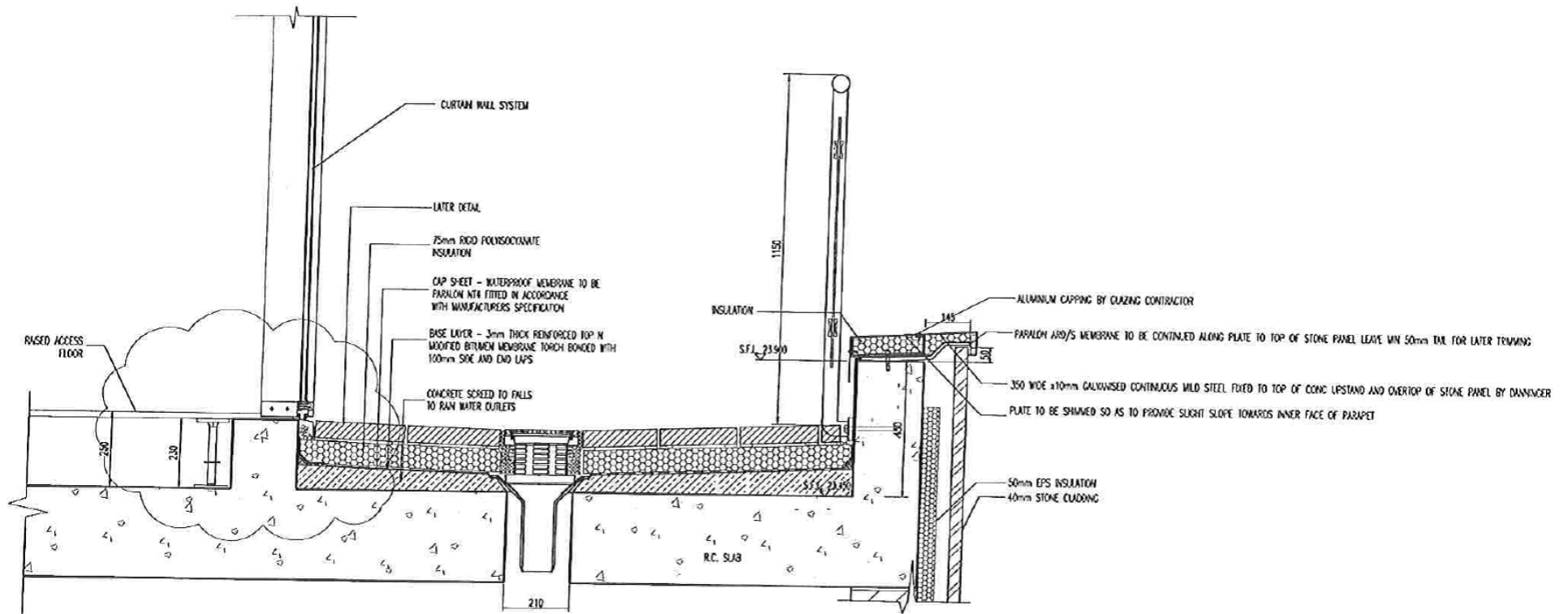

SECTION 17-17 BALCONY BUILD-UP AND RAIN WATER DRAINAGE

ROOF BALCONY DETAIL 2

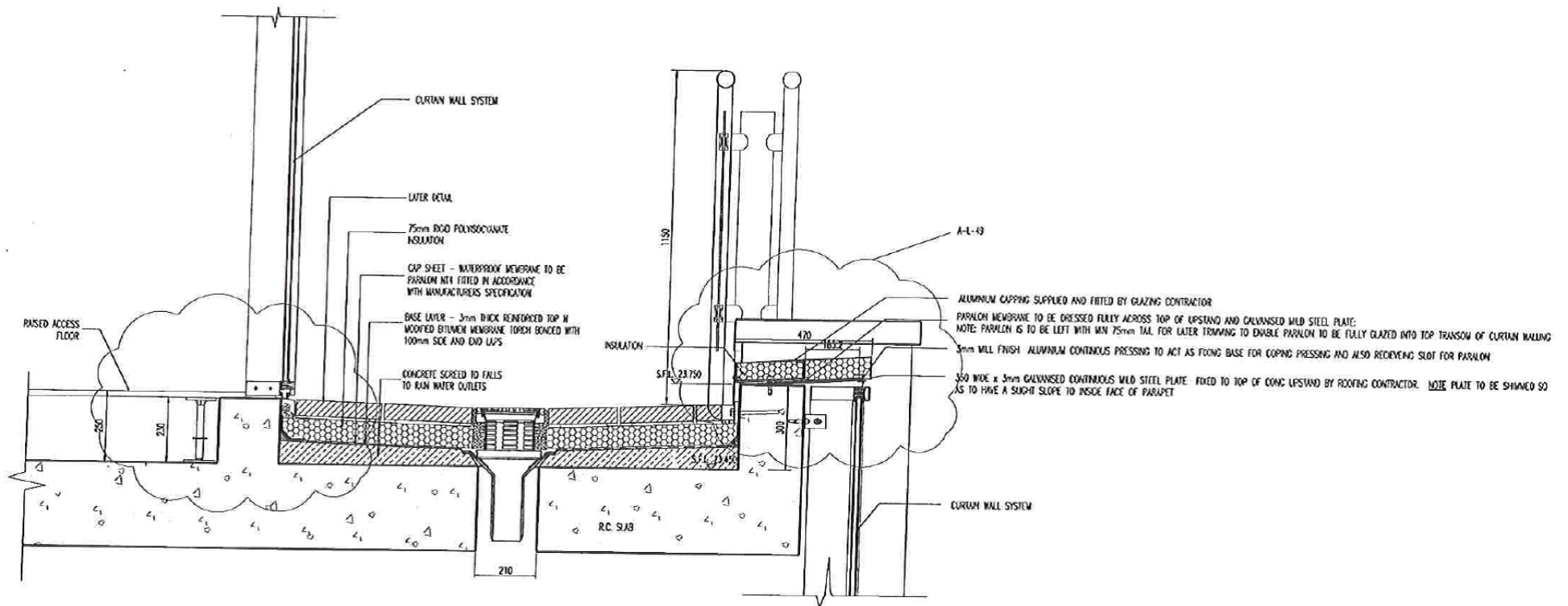

**SECTION 18-18 BALCONY BUILD-UP
AND RAIN WATER DRAINAGE**

3D CONSTRUCTION ROOF DETAILS 1

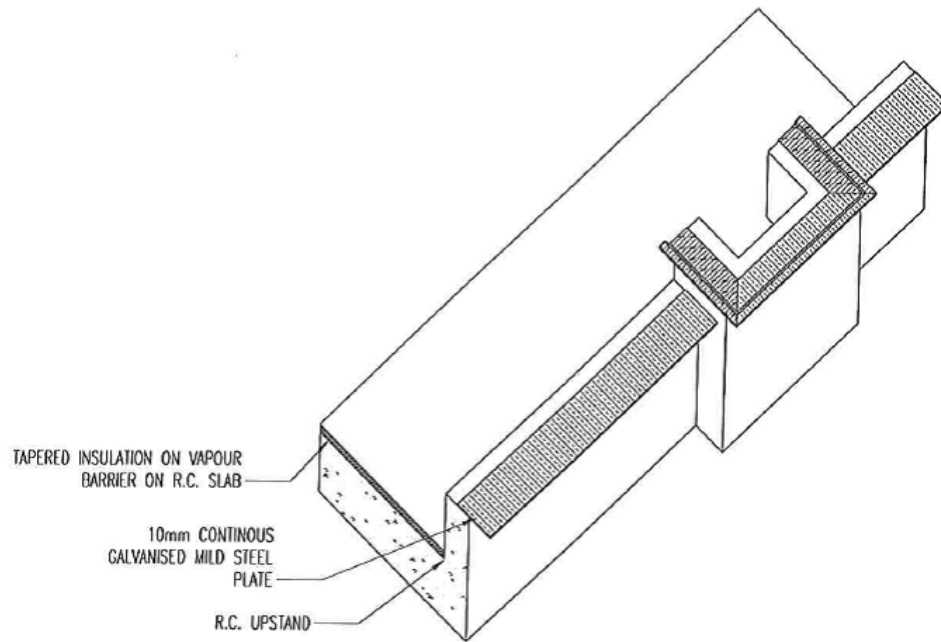

**CONCRETE UPSTANDS –
ROOF INSULATION AND METAL PLATES IN PLACE**

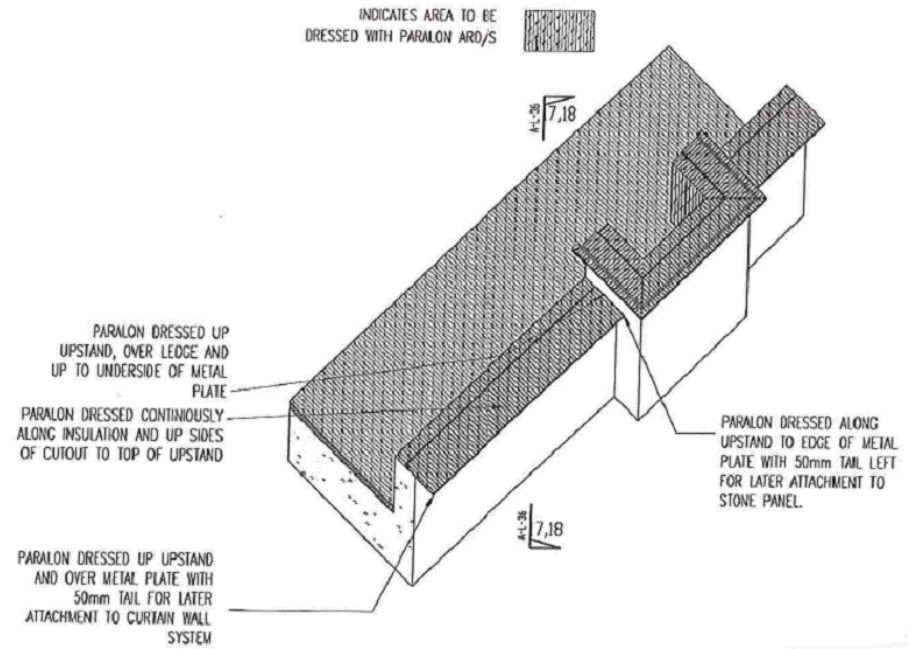

PARALON IN PLACE

3D CONSTRUCTION ROOF DETAILS 2

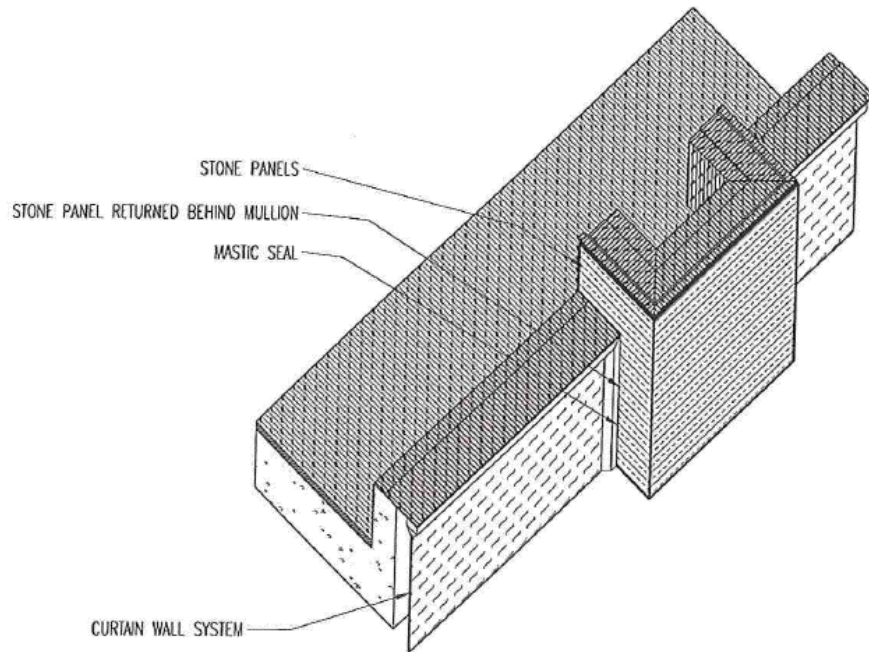

CURTAIL WALLING AND STONE PANELS IN PLACE

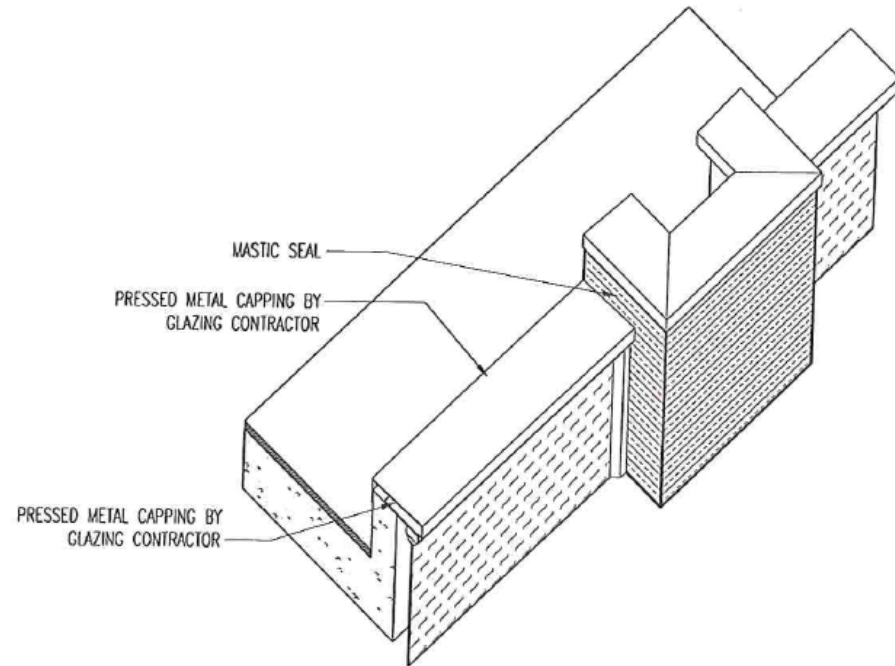

PRESSED METAL CAPPINGS IN PLACE

STAIR CORE CROSS SECTIONS

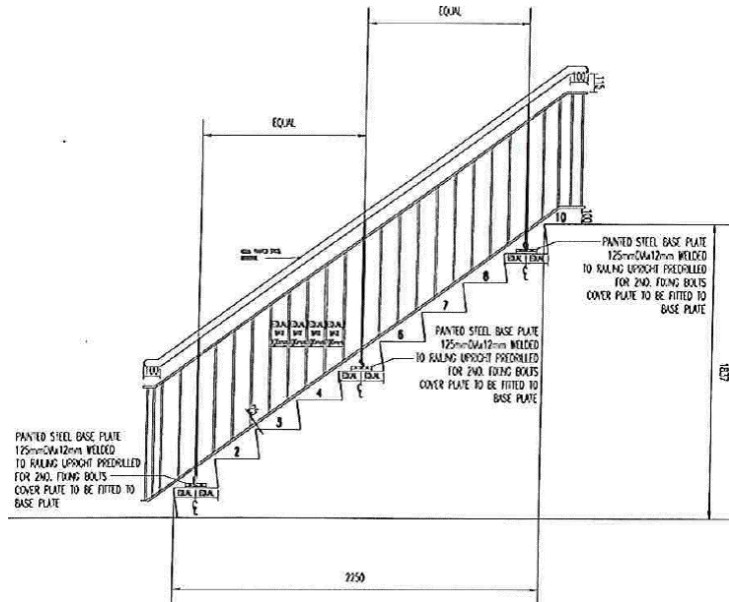

TYPICAL HAND RAIL DETAIL

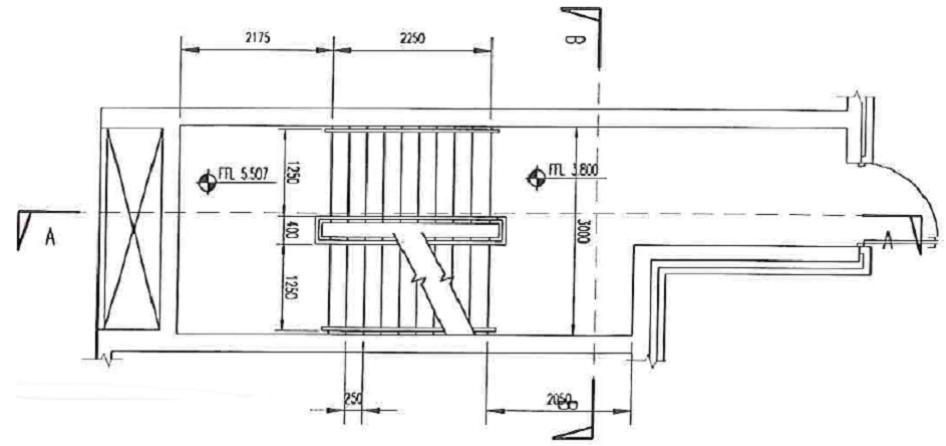

GROUND FLOOR STAIR CORE

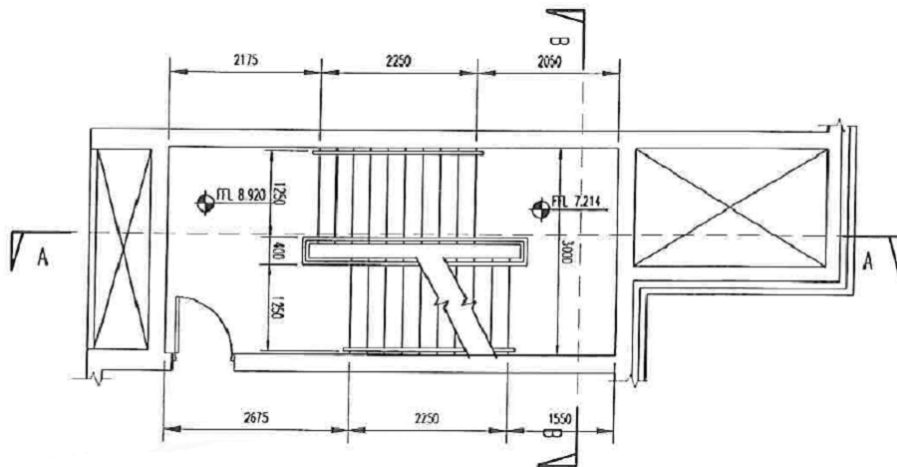

FIRST TO FOURTH FLOOR STAIR CORE

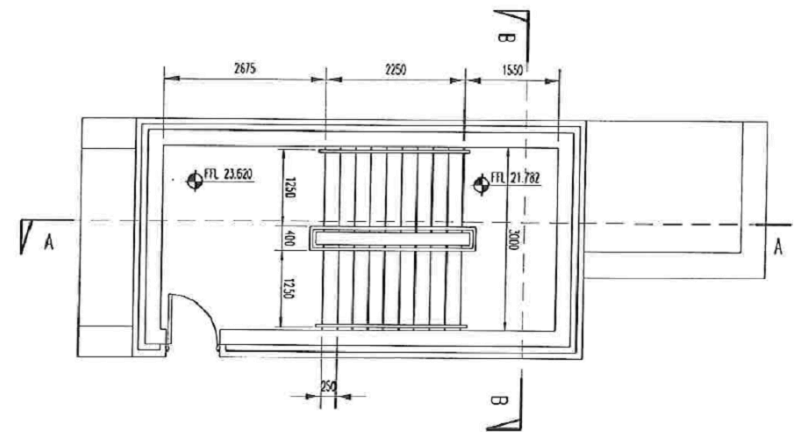

FIFTH FLOOR STAIR CORE

STAIR CORE SECTIONS

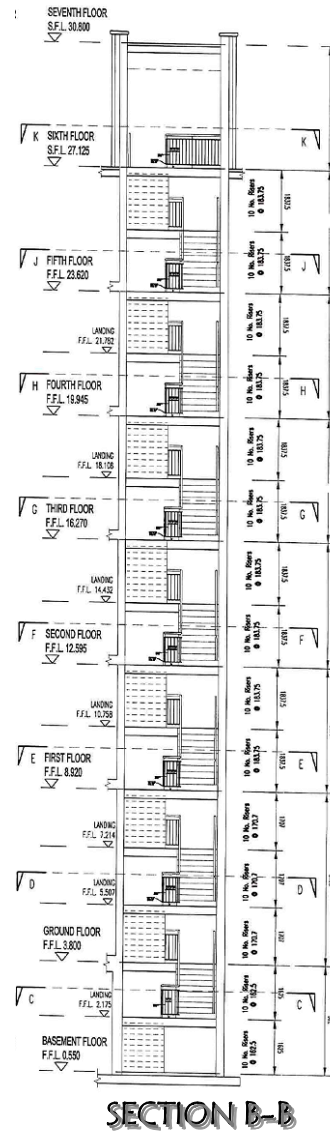
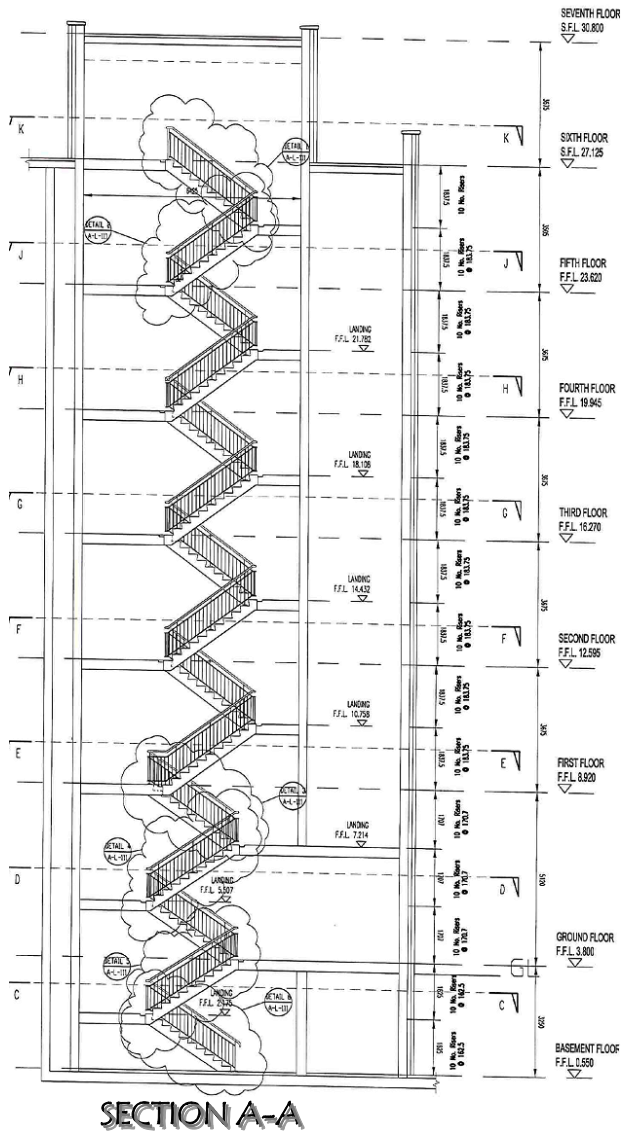

WINDOW SCHEDULE

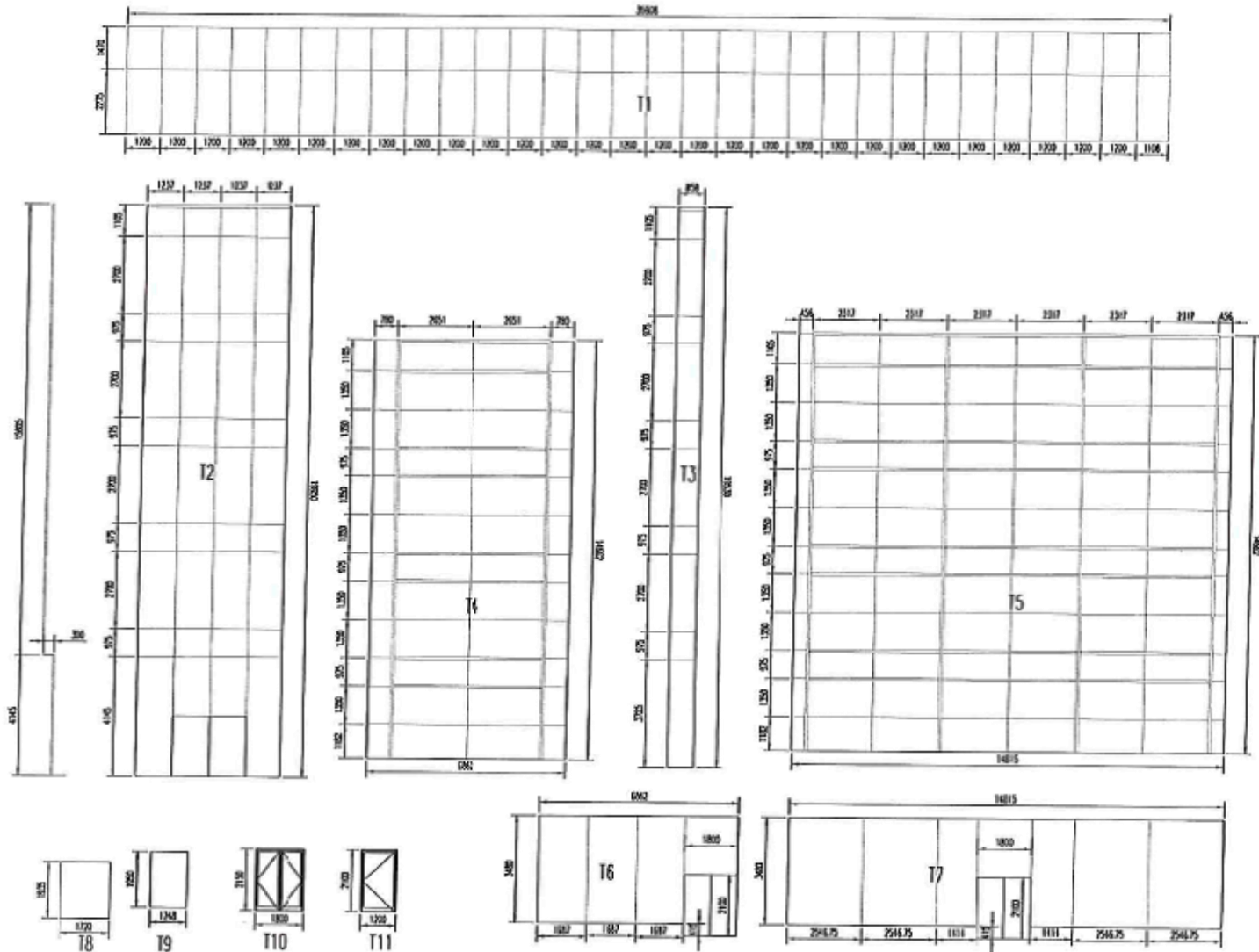

STONE SCHEDULE

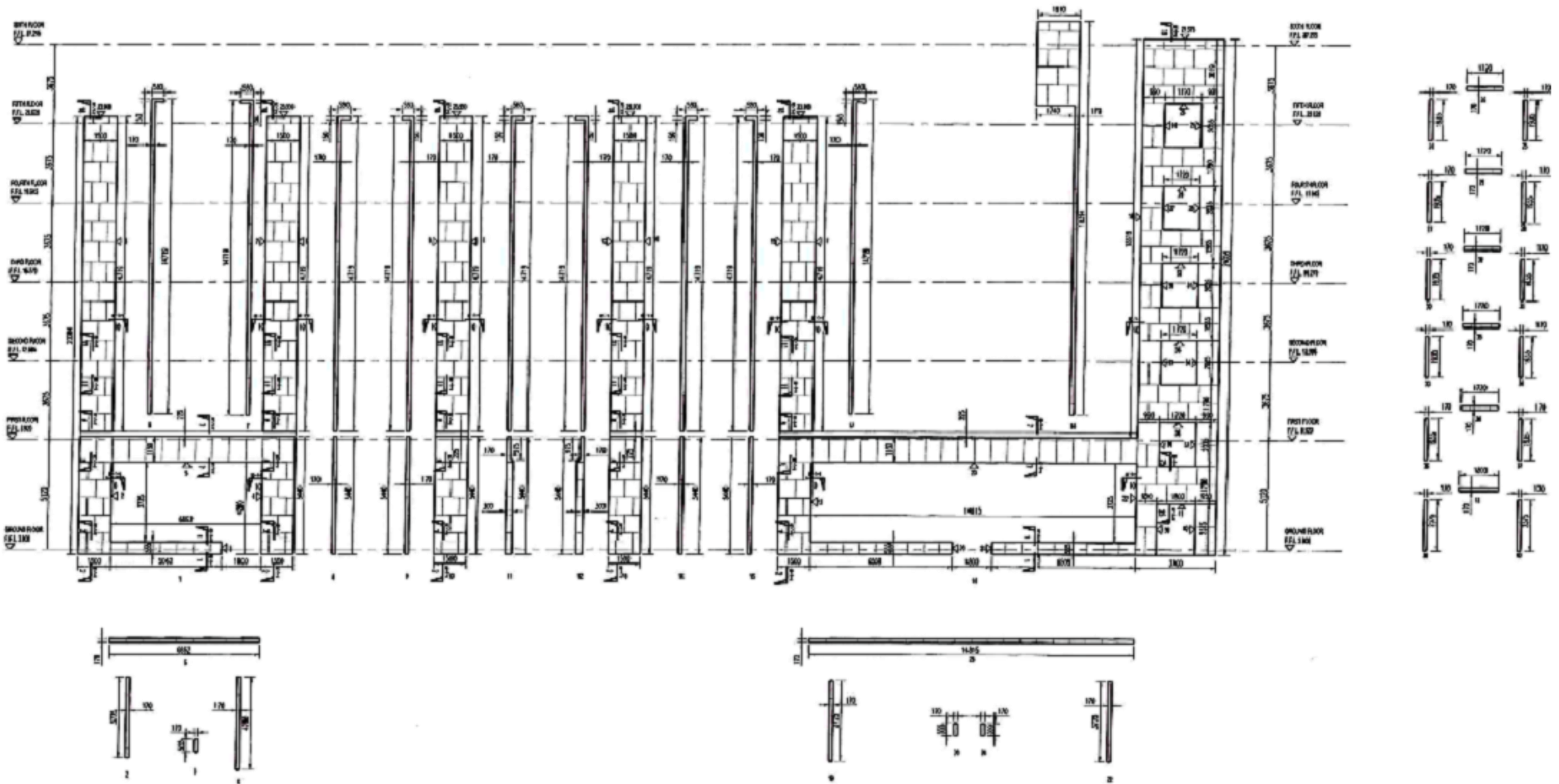

ROOF BALCONY SCHEDULE

